

Shuttle valves type WV and WVC

Valves for pipe connection
screw-in valves

Pressure p_{max} = 315 bar
Flow Q_{max} = 125 lpm

1. General information

The shuttle valve is a stop valve with two blockable inlets and one outlet. The inlet side with the higher pressure is connected to the outlet and the other inlet is blocked (DIN ISO 1219-1). The function is automatic.

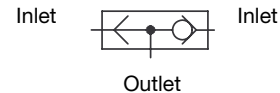

2. Available versions, main data

Connection manner	Coding	$\varnothing d^1$ (mm)	Pressure p_{max} (bar)	Flow Q_{max} (l/min)	Mass (weight) approx. (kg)	Schematic sectional drawing
For pipe connection	WV 6-S	6	315	6	120	
	WV 8-S	8		15	170	
	WV 10-S	10		25	230	
	WV 12-S	12		40	290	
	WV 14-S	14		60	320	
	WV 16-S	16		100	390	
	WV 18-L	18		125	350	
Screw-in valve	WVC 1	---	315	6	7	
	WVC 11 with PTFE threaded seal	---				

¹⁾ Precision tube, seamless, DIN 2391 and 1629, Sheet 4

3. Additional data

Design	Seated ball valve
Installation position	Any, freely suspended in the pipe system (WV..) or screwed into a manifold (WVC..)
Pipe connection	In the case of WV, via cutting ring fittings. The manufacturer's assembly instructions must be observed. e.g. ERMETO
Static overload capacity	$> 2 \times p_{max}$
Pressure fluid	Hydraulic oil conforming DIN 51524 part 1 to 3: ISO VG 10 to 68 conforming DIN 51519. Viscosity limits: min. approx. 4, max. approx. 1500 mm ² /sec; opt. operation: WV 6-S and WVC.. approx. 10 ... 300 mm ² /sec WV 8-S to WV 16-S approx. 10 ... 500 mm ² /sec A greater increase in the flow resistance can be expected for viscosities exceeding 300 mm ² /sec in the case of WV 6-(8)S and WVC.. and at viscosities over 500 mm ² /sec in the case of WV 8-S and WV 10-S. Also suitable for biological degradable pressure fluids types HEPG (Polyalkylenglycol) and HEES (Synth. Ester) at service temperatures up to approx. +70 °C.
Temperature	Ambient: approx. -40 ... +80 °C; Fluid: -25 ... +80 °C, Note the viscosity range! Permissible temperature during start: -40°C (Note start-viscosity!), as long as the service temperature is at least 20K higher for the following operation. Biological degradable pressure fluids: Note manufacturer's specifications. By consideration of the compatibility with seal material not over +70 °C.

Δp -Q curve

Type WV 6-S to WV 16-S

Type WVC 1 and WVC 11

Oil viscosity during the measurement
65 mm²/sec

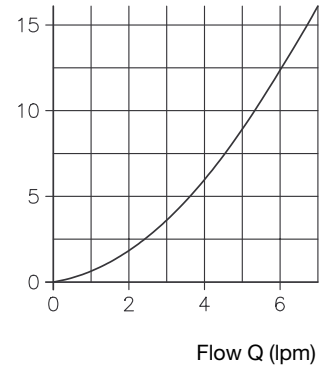
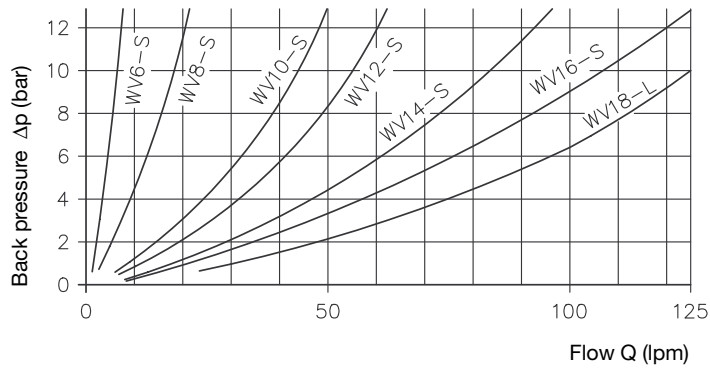

4. Unit dimensions

All dimensions are in mm and subject to change without notice !

Type WV 6-S to WV 18-L

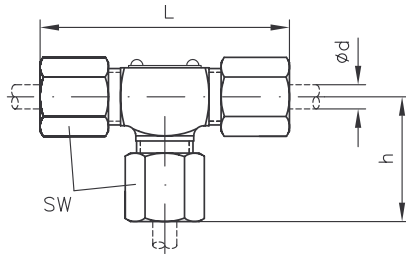

$SW = a/f$

Type	L	h	Ød	SW
WV 6-S	62	31	6	17
WV 8-S	64	32	8	19
WV 10-S	68	34	10	22
WV 12-S	76	38	12	24
WV 14-S	80	40	14	27
WV 16-S	86	43	16	30
WV 18-L	80	40	18	32

Type WVC 1

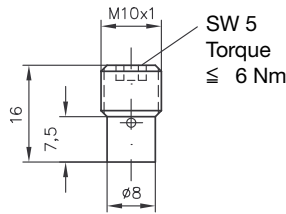

Type WVC 11

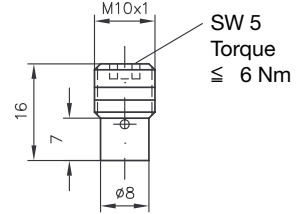

For mounting hole of customer furnished manifolds, see schematic drawing in sect. 2.

Mounting hole

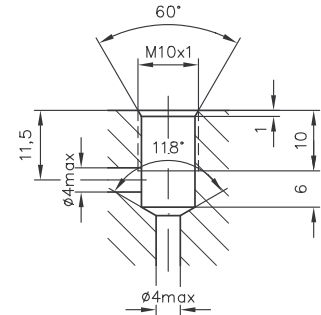
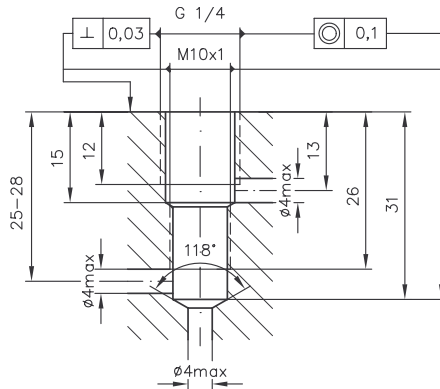

5. Application example

Combined remote control of prop. directional spool valves (e.g. type PSL and PSV acc. to D 7700 ++) via pressure reducing valves type FB and KFB acc. to D 6600.

